

Simulation Results for K&V - Art. 2102 - Trockeneis Frühling, Herbst

Created by Ivonsee on 2017-02-21 09:08:41

Box Summary

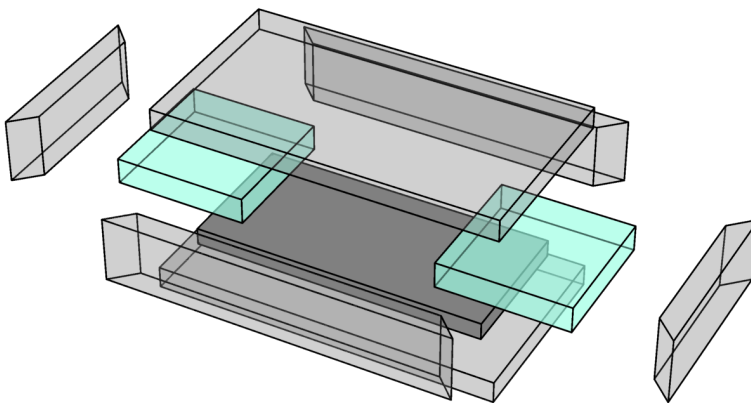

	Box Dimensions	
	Outer	Inner
Length	390.mm	340.mm
Width	215.mm	165.mm
Height	125.mm	75.mm
Volume	10.48 ltr.	4.21 ltr.

Wall	Thickness [mm]	Transmittance [W/(m ² K)]	Transmission [W/K]
Left	25.	1.44	0.02826
Right	25.	1.44	0.02826
Front	25.	1.44	0.05346
Back	25.	1.44	0.05346
Bottom	25.	1.44	0.100764
Top	25.	1.44	0.100764
			Σ = 0.364968

Sensor Temperatures

