

Simulation Results for K&V - Art. 2208 - Trockeneis Frühling, Herbst

Created by Ivonsee on 2017-03-03 11:36:09

Box Summary

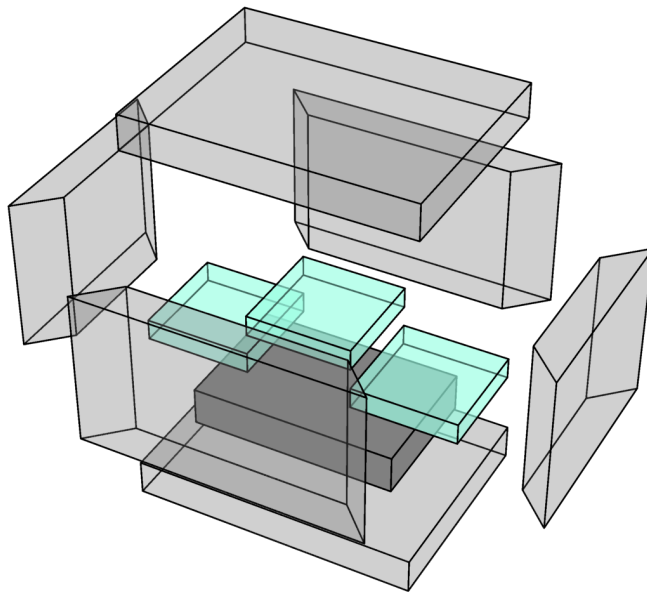

	Box Dimensions	
	Outer	Inner
Length	400.mm	300.mm
Width	300.mm	200.mm
Height	320.mm	220.mm
Volume	38.40 ltr.	13.20 ltr.

Wall	Thickness [mm]	Transmittance [W/(m ² K)]	Transmission [W/K]
Left	50.	0.78	0.0546
Right	50.	0.78	0.0546
Front	50.	0.78	0.07566
Back	50.	0.78	0.07566
Bottom	50.	0.78	0.0702
Top	50.	0.78	0.0702
			Σ = 0.40092

Sensor Temperatures

