

# Simulation Results for K&V - Art. 2010 - Winter

Created by Ivonsee on 2016-09-22 15:14:55

## Box Summary

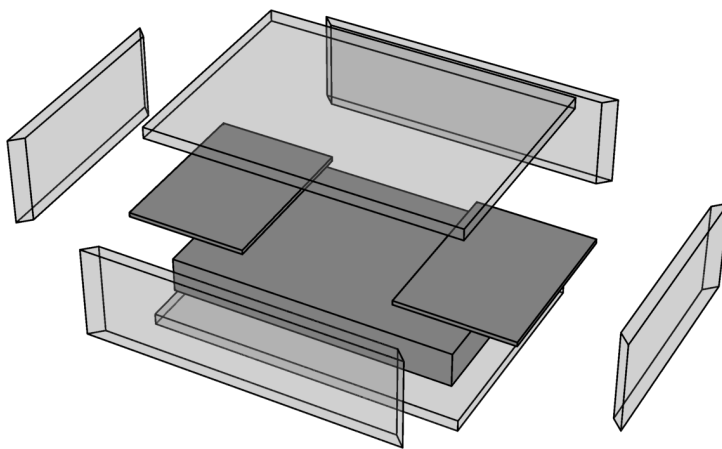

	Box Dimensions	
	Outer	Inner
Length	675.mm	625.mm
Width	480.mm	430.mm
Height	250.mm	200.mm
Volume	81.00 ltr.	53.75 ltr.

Wall	Thickness [mm]	Transmittance [W/(m <sup>2</sup> K)]	Transmission [W/K]
Left	25.	1.44	0.14832
Right	25.	1.44	0.14832
Front	25.	1.44	0.2115
Back	25.	1.44	0.2115
Bottom	25.	1.44	0.42678
Top	25.	1.44	0.42678
			<b>Σ = 1.5732</b>

# Sensor Temperatures

