

Simulation Results for K&V - Art. 2020 - Winter

Created by Ivonsee on 2016-09-22 16:26:57

Box Summary

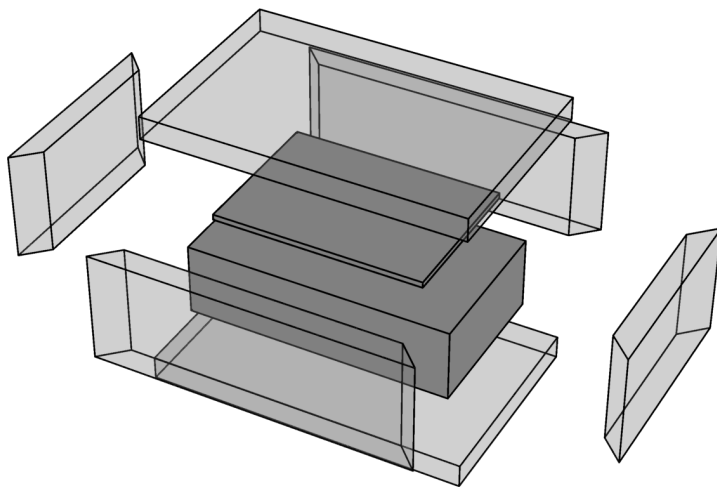

	Box Dimensions	
	Outer	Inner
Length	545.mm	465.mm
Width	355.mm	275.mm
Height	270.mm	190.mm
Volume	52.24 ltr.	24.30 ltr.

Wall	Thickness [mm]	Transmittance [W/(m²K)]	Transmission [W/K]
Left	40.	0.9	0.066645
Right	40.	0.9	0.066645
Front	40.	0.9	0.105975
Back	40.	0.9	0.105975
Bottom	40.	0.9	0.144608
Top	40.	0.9	0.144608
			Σ = 0.634455

Sensor Temperatures

