

Simulation Results for K&V - Art. 2021 - Frühling, Herbst

Created by Ivonsee on 2016-09-29 12:38:56

Box Summary

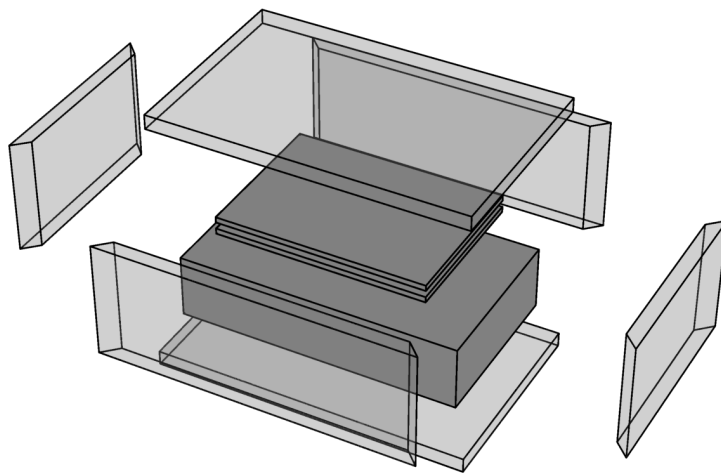

	Box Dimensions	
	Outer	Inner
Length	540.mm	490.mm
Width	345.mm	295.mm
Height	250.mm	200.mm
Volume	46.58 ltr.	28.91 ltr.

Wall	Thickness [mm]	Transmittance [W/(m²K)]	Transmission [W/K]
Left	25.	1.44	0.10458
Right	25.	1.44	0.10458
Front	25.	1.44	0.16776
Back	25.	1.44	0.16776
Bottom	25.	1.44	0.238212
Top	25.	1.44	0.238212
			Σ = 1.0211

Sensor Temperatures

