

Simulation Results for K&V - Art. 2023 - Winter

Created by Ivonsee on 2016-09-30 09:33:43

Box Summary

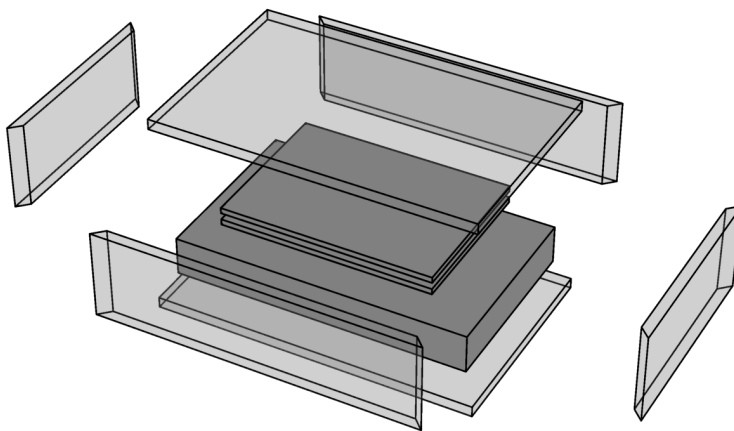

	Box Dimensions	
	Outer	Inner
Length	545.mm	509.mm
Width	350.mm	314.mm
Height	186.mm	150.mm
Volume	35.48 ltr.	23.97 ltr.

Wall	Thickness [mm]	Transmittance [W/(m ² K)]	Transmission [W/K]
Left	18.	2.	0.1122
Right	18.	2.	0.1122
Front	18.	2.	0.17772
Back	18.	2.	0.17772
Bottom	18.	2.	0.350576
Top	18.	2.	0.350576
			Σ = 1.28099

Sensor Temperatures

