

# Simulation Results for K&V - Art. 2030 - Winter

Created by Ivonsee on 2016-09-30 13:19:54

## Box Summary

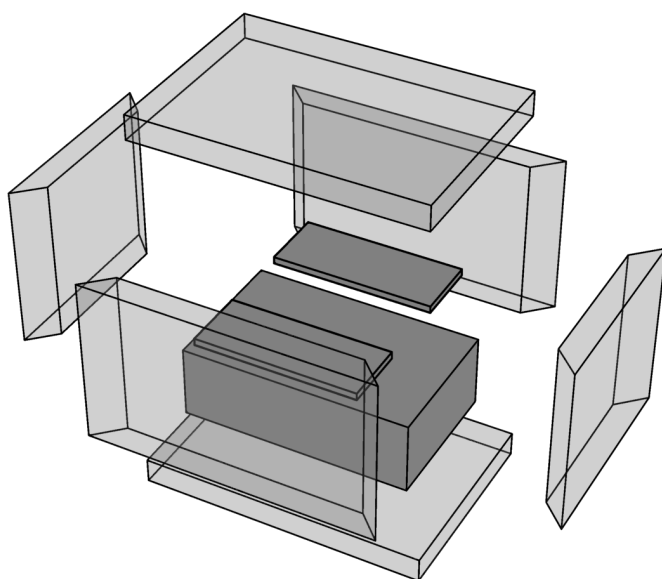

	Box Dimensions	
	Outer	Inner
Length	460.mm	380.mm
Width	320.mm	240.mm
Height	345.mm	265.mm
Volume	50.78 ltr.	24.17 ltr.

Wall	Thickness [mm]	Transmittance [W/(m <sup>2</sup> K)]	Transmission [W/K]
Left	40.	0.9	0.0783
Right	40.	0.9	0.0783
Front	40.	0.9	0.11673
Back	40.	0.9	0.11673
Bottom	40.	0.9	0.10728
Top	40.	0.9	0.10728
			<b>Σ = 0.60462</b>

# Sensor Temperatures

