

Simulation Results for K&V - Art. 2040 - Sommer

Created by Ivonsee on 2016-09-30 14:43:30

Box Summary

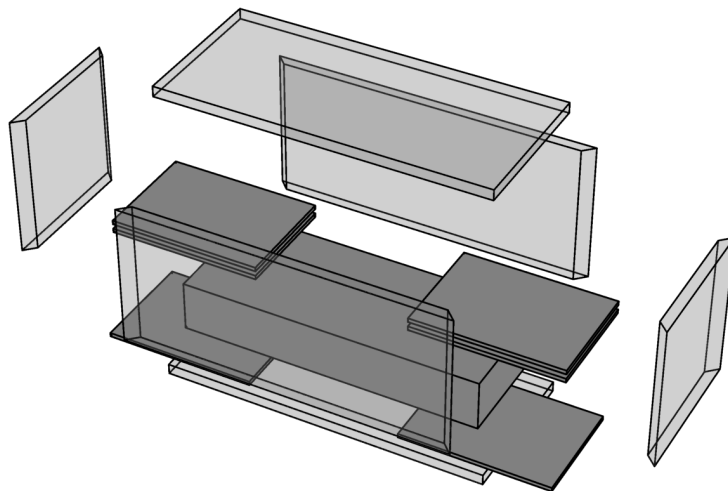

	Box Dimensions	
	Outer	Inner
Length	775.mm	725.mm
Width	350.mm	300.mm
Height	390.mm	340.mm
Volume	105.79 ltr.	73.95 ltr.

Wall	Thickness [mm]	Transmittance [W/(m ² K)]	Transmission [W/K]
Left	25.	1.44	0.17172
Right	25.	1.44	0.17172
Front	25.	1.44	0.3951
Back	25.	1.44	0.3951
Bottom	25.	1.44	0.3519
Top	25.	1.44	0.3519
			Σ = 1.83744

Sensor Temperatures

