

Simulation Results for K&V - Art. 2050 - Frühling, Herbst

Created by Ivonsee on 2016-10-04 08:56:36

Box Summary

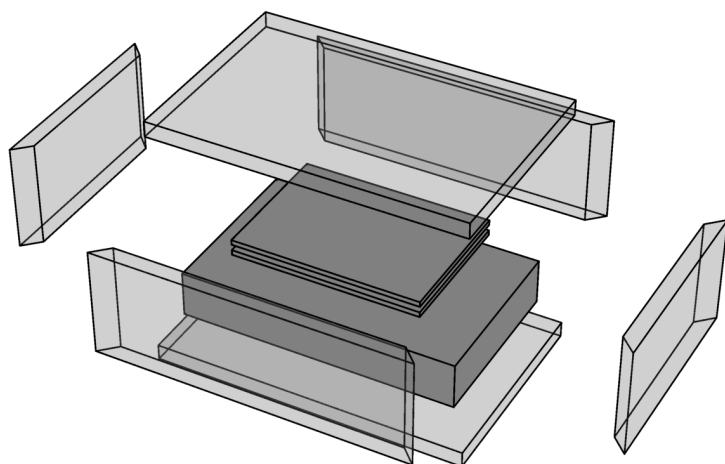

	Box Dimensions	
	Outer	Inner
Length	595.mm	535.mm
Width	395.mm	335.mm
Height	265.mm	205.mm
Volume	62.28 ltr.	36.74 ltr.

Wall	Thickness [mm]	Transmittance [W/(m ² K)]	Transmission [W/K]
Left	30.	1.2	0.10401
Right	30.	1.2	0.10401
Front	30.	1.2	0.16041
Back	30.	1.2	0.16041
Bottom	30.	1.2	0.24855
Top	30.	1.2	0.24855
			Σ = 1.02594

Sensor Temperatures

