

# Simulation Results for K&V - Art. 2051 - Sommer

Created by Ivonsee on 2016-10-04 09:04:08

## Box Summary

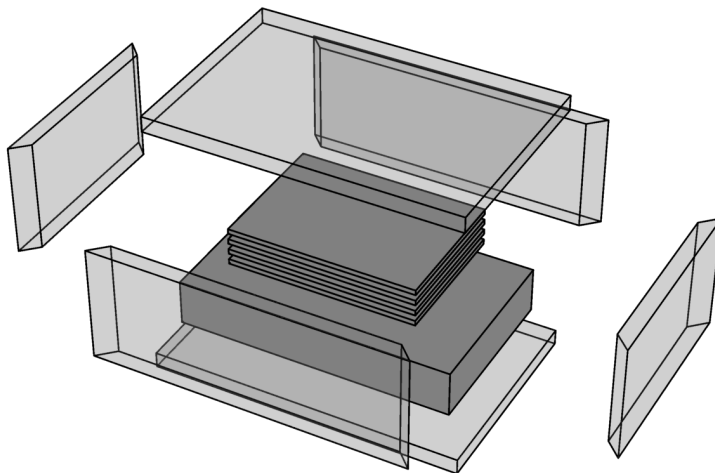

	Box Dimensions	
	Outer	Inner
Length	595.mm	535.mm
Width	395.mm	335.mm
Height	280.mm	220.mm
Volume	65.81 ltr.	39.43 ltr.

Wall	Thickness [mm]	Transmittance [W/(m²K)]	Transmission [W/K]
Left	30.	1.2	0.11058
Right	30.	1.2	0.11058
Front	30.	1.2	0.17058
Back	30.	1.2	0.17058
Bottom	30.	1.2	0.24855
Top	30.	1.2	0.24855
			<b>Σ = 1.05942</b>

# Sensor Temperatures

