

# Simulation Results for K&V - Art. 2052 - Sommer

Created by Ivonsee on 2016-10-04 09:38:45

## Box Summary

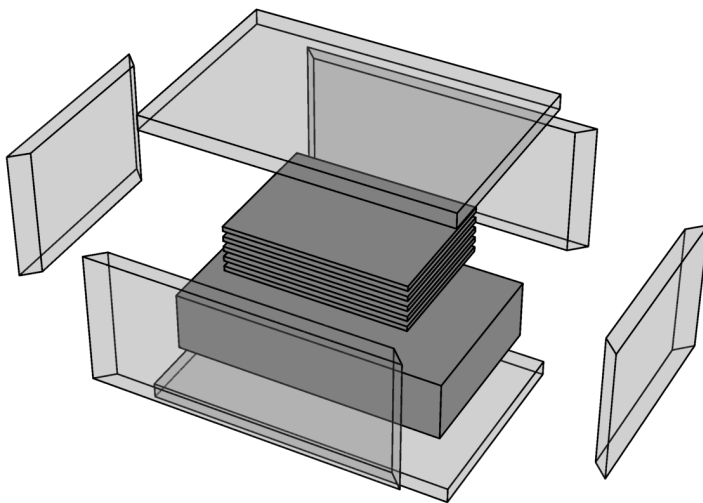

	Box Dimensions	
	Outer	Inner
Length	595.mm	535.mm
Width	395.mm	335.mm
Height	320.mm	260.mm
Volume	75.21 ltr.	46.60 ltr.

Wall	Thickness [mm]	Transmittance [W/(m <sup>2</sup> K)]	Transmission [W/K]
Left	30.	1.2	0.1281
Right	30.	1.2	0.1281
Front	30.	1.2	0.1977
Back	30.	1.2	0.1977
Bottom	30.	1.2	0.24855
Top	30.	1.2	0.24855
			<b>Σ = 1.1487</b>

# Sensor Temperatures

