

Simulation Results for K&V - Art. 2053 - Frühling, Herbst

Created by Ivonsee on 2016-10-04 10:02:28

Box Summary

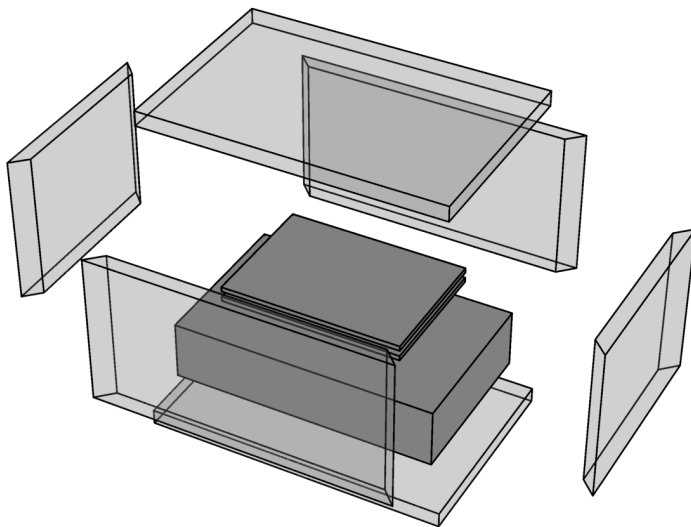

	Box Dimensions	
	Outer	Inner
Length	595.mm	535.mm
Width	395.mm	335.mm
Height	360.mm	300.mm
Volume	84.61 ltr.	53.77 ltr.

Wall	Thickness [mm]	Transmittance [W/(m²K)]	Transmission [W/K]
Left	30.	1.2	0.14562
Right	30.	1.2	0.14562
Front	30.	1.2	0.22482
Back	30.	1.2	0.22482
Bottom	30.	1.2	0.24855
Top	30.	1.2	0.24855
			Σ = 1.23798

Sensor Temperatures

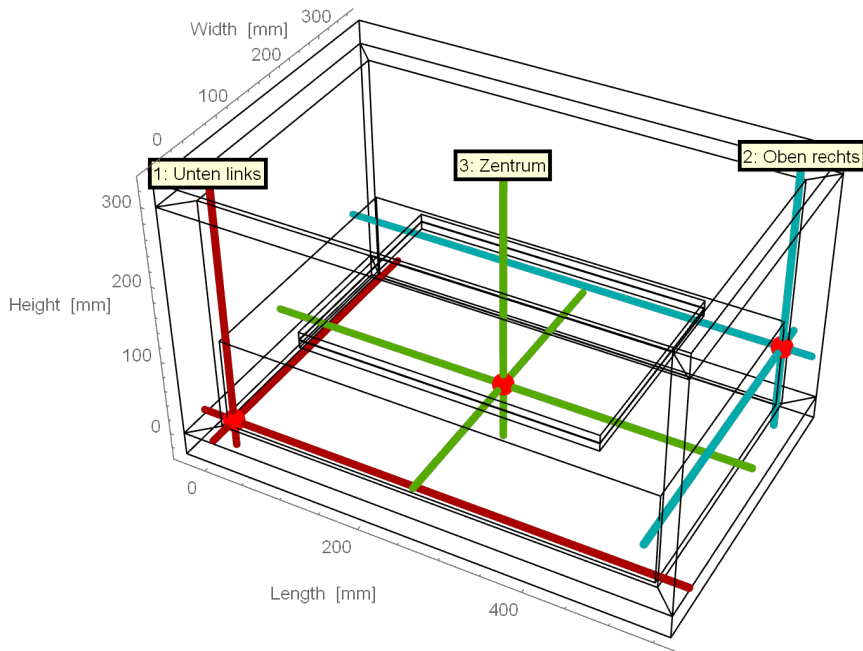

— Ambience — Sensor 1: Unten links
— Sensor 2: Oben rechts — Sensor 3: Zentrum

