

# Simulation Results for K&V - Art. 2054 - Sommer

Created by Ivonsee on 2016-10-04 10:16:48

## Box Summary

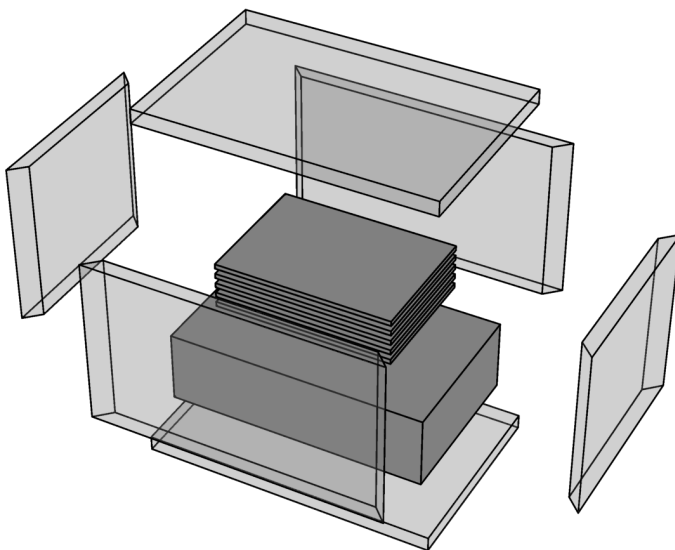

	Box Dimensions	
	Outer	Inner
Length	595.mm	535.mm
Width	395.mm	335.mm
Height	400.mm	340.mm
Volume	94.01 ltr.	60.94 ltr.

Wall	Thickness [mm]	Transmittance [W/(m²K)]	Transmission [W/K]
Left	30.	1.2	0.16314
Right	30.	1.2	0.16314
Front	30.	1.2	0.25194
Back	30.	1.2	0.25194
Bottom	30.	1.2	0.24855
Top	30.	1.2	0.24855
			<b>Σ = 1.32726</b>

# Sensor Temperatures

