

Simulation Results for K&V - Art. 2059 - Winter

Created by Ivonsee on 2016-10-04 11:24:44

Box Summary

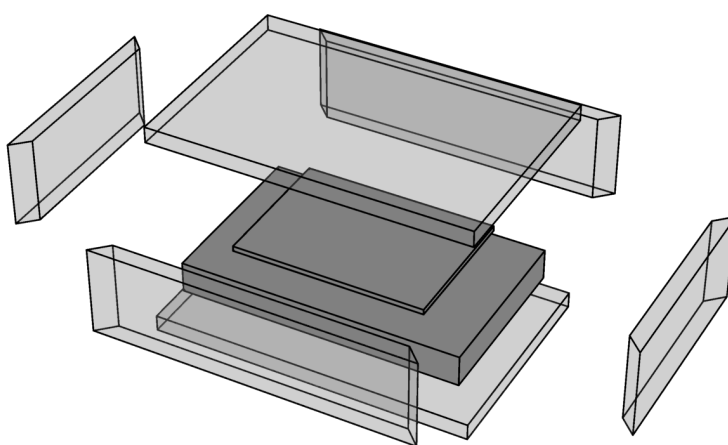

	Box Dimensions	
	Outer	Inner
Length	595.mm	535.mm
Width	395.mm	335.mm
Height	225.mm	165.mm
Volume	52.88 ltr.	29.57 ltr.

Wall	Thickness [mm]	Transmittance [W/(m ² K)]	Transmission [W/K]
Left	30.	1.2	0.08649
Right	30.	1.2	0.08649
Front	30.	1.2	0.13329
Back	30.	1.2	0.13329
Bottom	30.	1.2	0.24855
Top	30.	1.2	0.24855
			Σ = 0.93666

Sensor Temperatures

