

Simulation Results for K&V - Art. 2060 - Sommer

Created by Ivonsee on 2016-10-05 10:13:40

Box Summary

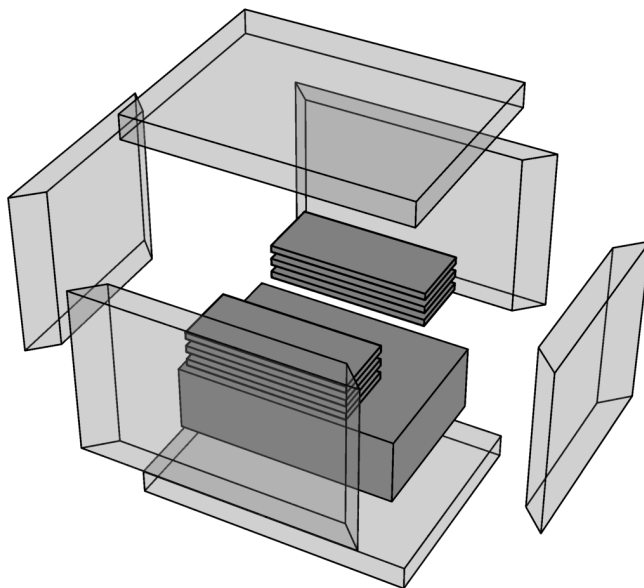

	Box Dimensions	
	Outer	Inner
Length	450.mm	370.mm
Width	340.mm	260.mm
Height	360.mm	280.mm
Volume	55.08 ltr.	26.94 ltr.

Wall	Thickness [mm]	Transmittance [W/(m ² K)]	Transmission [W/K]
Left	40.	0.9	0.08784
Right	40.	0.9	0.08784
Front	40.	0.9	0.11952
Back	40.	0.9	0.11952
Bottom	40.	0.9	0.11214
Top	40.	0.9	0.11214
			Σ = 0.639

Sensor Temperatures

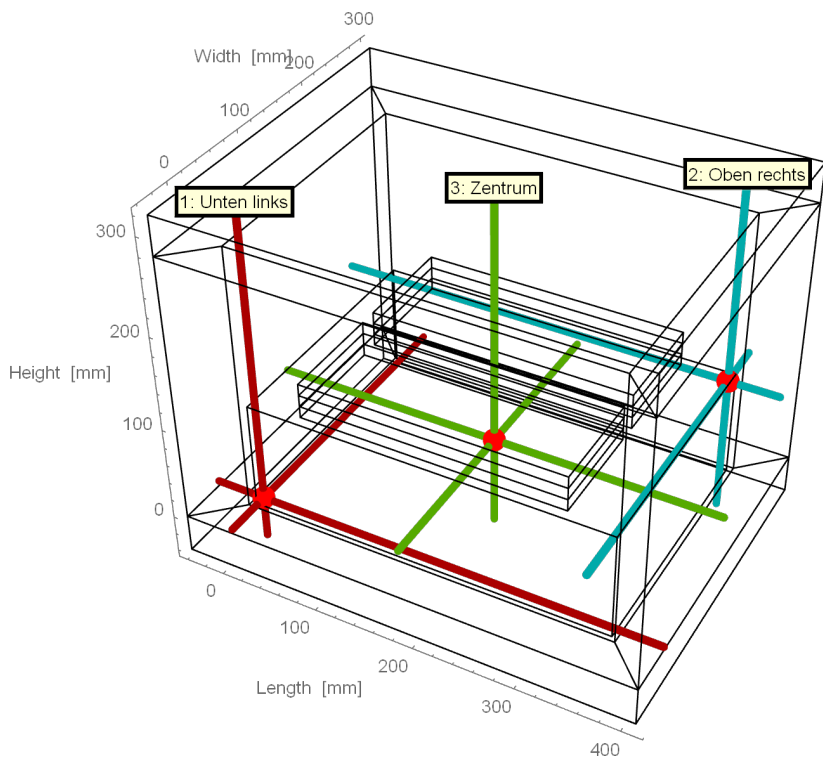

— Ambience — Sensor 1: Unten links
— Sensor 2: Oben rechts — Sensor 3: Zentrum

