

Simulation Results for K&V - Art. 2062 - Winter

Created by Ivonsee on 2016-10-05 11:35:39

Box Summary

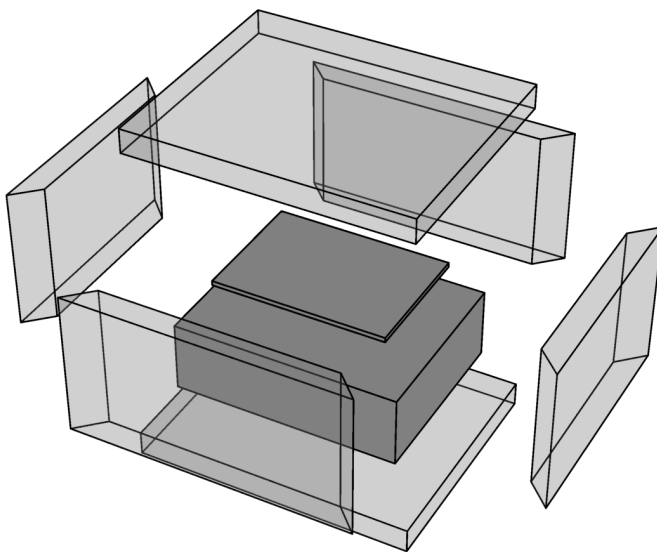

	Box Dimensions	
	Outer	Inner
Length	575.mm	475.mm
Width	480.mm	380.mm
Height	395.mm	295.mm
Volume	109.02 ltr.	53.25 ltr.

Wall	Thickness [mm]	Transmittance [W/(m²K)]	Transmission [W/K]
Left	50.	0.72	0.108612
Right	50.	0.72	0.108612
Front	50.	0.72	0.13221
Back	50.	0.72	0.13221
Bottom	50.	0.72	0.16434
Top	50.	0.72	0.16434
			Σ = 0.810324

Sensor Temperatures

