

Simulation Results for K&V - Art. 2063 - Winter

Created by Ivonsee on 2016-10-05 11:58:18

Box Summary

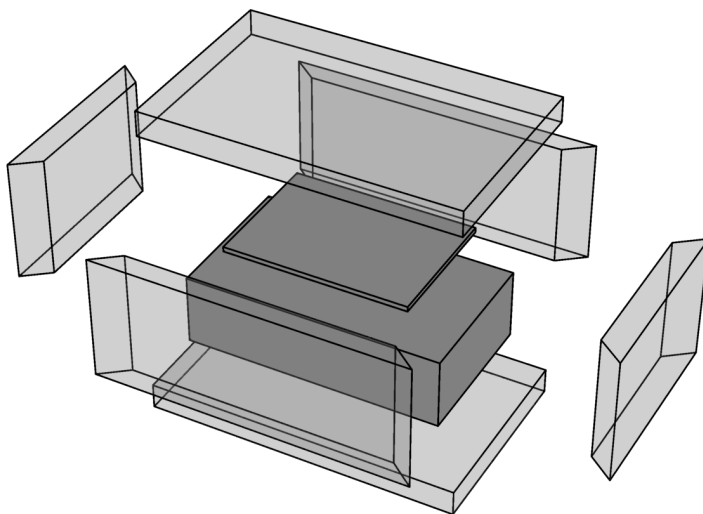

	Box Dimensions	
	Outer	Inner
Length	610.mm	510.mm
Width	380.mm	300.mm
Height	345.mm	245.mm
Volume	79.97 ltr.	37.49 ltr.

Wall	Thickness [mm]	Transmittance [W/(m ² K)]	Transmission [W/K]
Left	50.	0.72	0.073656
Right	50.	0.72	0.073656
Front	40.	0.9	0.15093
Back	40.	0.9	0.15093
Bottom	50.	0.72	0.138528
Top	50.	0.72	0.138528
			Σ = 0.726228

Sensor Temperatures

