

# Simulation Results for K&V - Art. 2064 - Frühling, Herbst

Created by Ivonsee on 2016-10-05 15:53:18

## Box Summary

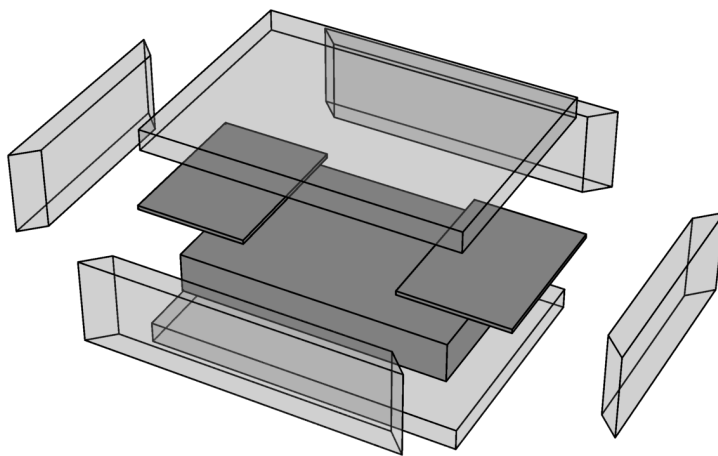

	Box Dimensions	
	Outer	Inner
Length	730.mm	630.mm
Width	530.mm	430.mm
Height	300.mm	200.mm
Volume	116.07 ltr.	54.18 ltr.

Wall	Thickness [mm]	Transmittance [W/(m <sup>2</sup> K)]	Transmission [W/K]
Left	50.	0.72	0.0882
Right	50.	0.72	0.0882
Front	50.	0.72	0.1242
Back	50.	0.72	0.1242
Bottom	50.	0.72	0.236808
Top	50.	0.72	0.236808
			<b>Σ = 0.898416</b>

# Sensor Temperatures

