

Simulation Results for K&V - Art. 2081 - Winter

Created by Ivonsee on 2016-10-05 17:22:02

Box Summary

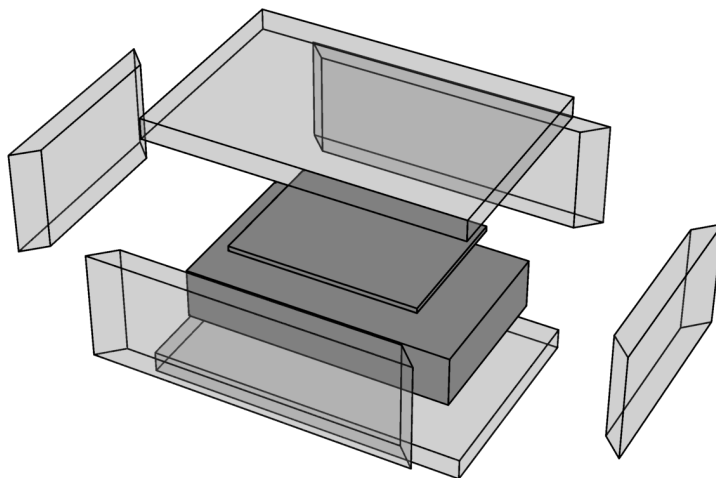

	Box Dimensions	
	Outer	Inner
Length	595.mm	515.mm
Width	395.mm	315.mm
Height	285.mm	205.mm
Volume	66.98 ltr.	33.26 ltr.

Wall	Thickness [mm]	Transmittance [W/(m²K)]	Transmission [W/K]
Left	40.	0.9	0.0797175
Right	40.	0.9	0.0797175
Front	40.	0.9	0.123817
Back	40.	0.9	0.123817
Bottom	40.	0.9	0.178763
Top	40.	0.9	0.178763
			Σ = 0.764595

Sensor Temperatures

