

# Simulation Results for K&V - Art. 2101 - Winter

Created by Ivonsee on 2016-09-21 13:04:12

## Box Summary

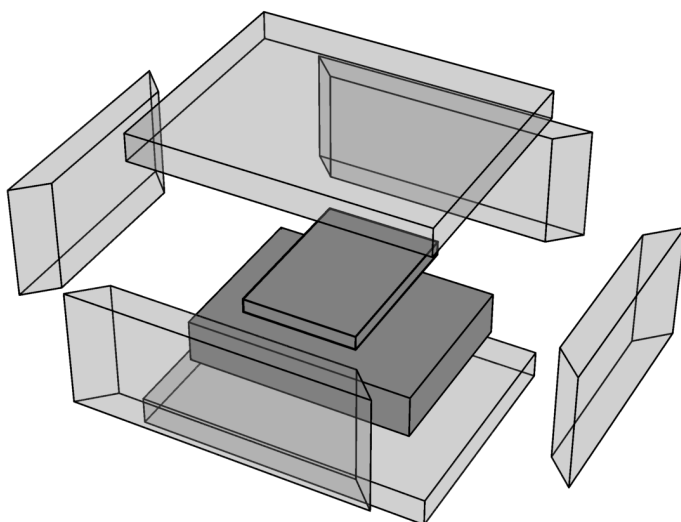

	Box Dimensions	
	Outer	Inner
Length	310.mm	250.mm
Width	250.mm	190.mm
Height	185.mm	125.mm
Volume	14.34 ltr.	5.94 ltr.

Wall	Thickness [mm]	Transmittance [W/(m <sup>2</sup> K)]	Transmission [W/K]
Left	30.	1.2	0.042
Right	30.	1.2	0.042
Front	30.	1.2	0.05316
Back	30.	1.2	0.05316
Bottom	30.	1.2	0.075
Top	30.	1.2	0.075
			<b>Σ = 0.34032</b>

# Sensor Temperatures

