

Simulation Results for K&V - Art. 2104 - Winter

Created by Ivonsee on 2016-09-22 11:35:09

Box Summary

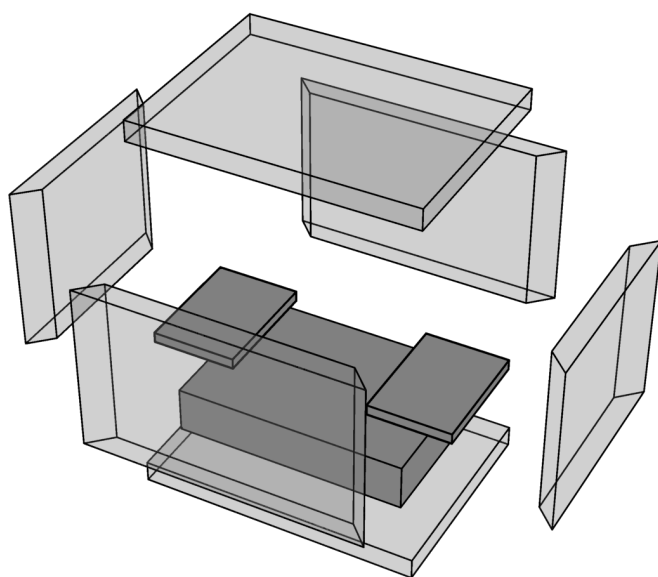

	Box Dimensions	
	Outer	Inner
Length	400.mm	340.mm
Width	300.mm	240.mm
Height	300.mm	240.mm
Volume	36.00 ltr.	19.58 ltr.

Wall	Thickness [mm]	Transmittance [W/(m ² K)]	Transmission [W/K]
Left	30.	1.2	0.08856
Right	30.	1.2	0.08856
Front	30.	1.2	0.12096
Back	30.	1.2	0.12096
Bottom	30.	1.2	0.12096
Top	30.	1.2	0.12096
			Σ = 0.66096

Sensor Temperatures

