

Simulation Results for K&V - Art. 2108 - Sommer

Created by Ivonsee on 2016-10-06 09:15:31

Box Summary

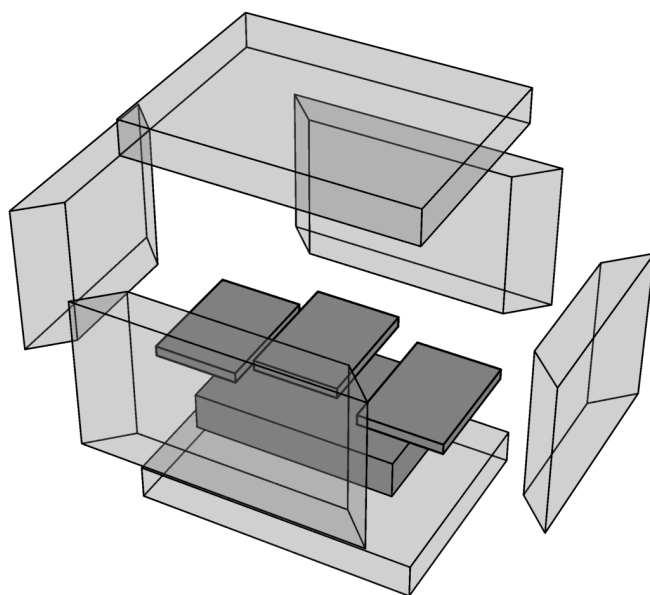

	Box Dimensions	
	Outer	Inner
Length	400.mm	300.mm
Width	300.mm	200.mm
Height	320.mm	220.mm
Volume	38.40 ltr.	13.20 ltr.

Wall	Thickness [mm]	Transmittance [W/(m ² K)]	Transmission [W/K]
Left	50.	0.72	0.0504
Right	50.	0.72	0.0504
Front	50.	0.72	0.06984
Back	50.	0.72	0.06984
Bottom	50.	0.72	0.0648
Top	50.	0.72	0.0648
			Σ = 0.37008

Sensor Temperatures

