

Simulation Results for K&V - Art. 2204 - Frühling, Herbst

Created by Ivonsee on 2016-10-06 10:56:25

Box Summary

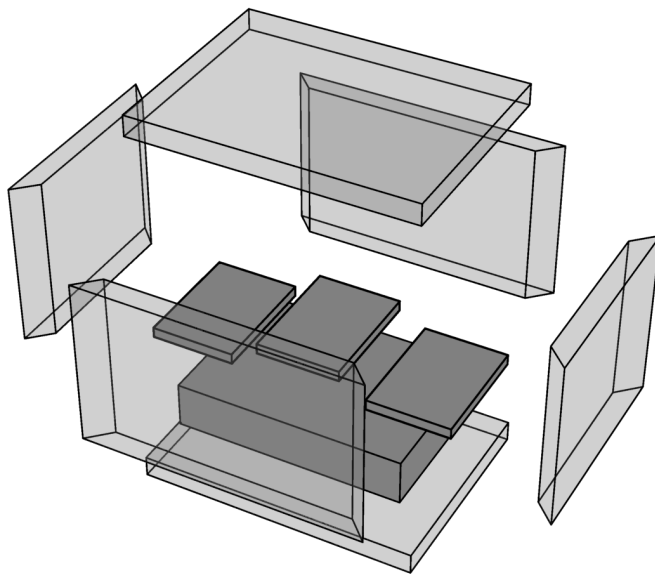

	Box Dimensions	
	Outer	Inner
Length	400.mm	340.mm
Width	300.mm	240.mm
Height	300.mm	240.mm
Volume	36.00 ltr.	19.58 ltr.

Wall	Thickness [mm]	Transmittance [W/(m ² K)]	Transmission [W/K]
Left	30.	1.3	0.09594
Right	30.	1.3	0.09594
Front	30.	1.3	0.13104
Back	30.	1.3	0.13104
Bottom	30.	1.3	0.13104
Top	30.	1.3	0.13104
			Σ = 0.71604

Sensor Temperatures

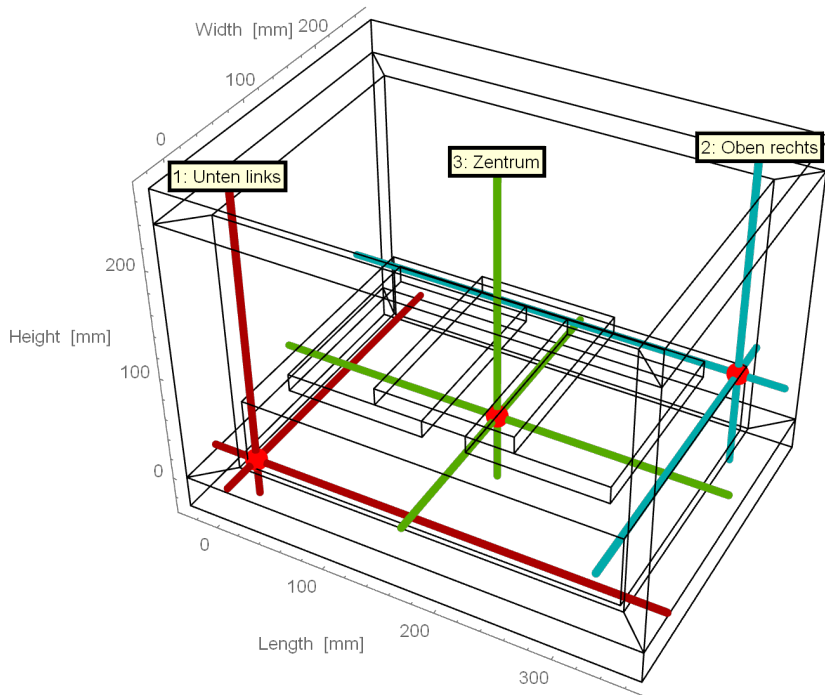

— Ambience — Sensor 1: Unten links
— Sensor 2: Oben rechts — Sensor 3: Zentrum

