

Simulation Results for K&V - Art. 2250 - Winter

Created by Ivonsee on 2016-10-06 14:07:44

Box Summary

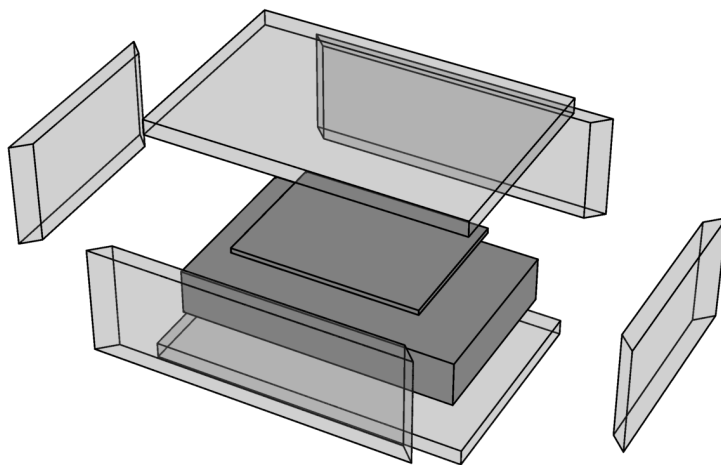

	Box Dimensions	
	Outer	Inner
Length	595.mm	535.mm
Width	395.mm	335.mm
Height	265.mm	205.mm
Volume	62.28 ltr.	36.74 ltr.

Wall	Thickness [mm]	Transmittance [W/(m²K)]	Transmission [W/K]
Left	30.	1.3	0.112678
Right	30.	1.3	0.112678
Front	30.	1.3	0.173778
Back	30.	1.3	0.173778
Bottom	30.	1.3	0.269263
Top	30.	1.3	0.269263
			Σ = 1.11144

Sensor Temperatures

