

Simulation Results for K&V - Art. 2252 - Sommer

Created by Ivonsee on 2016-10-06 16:04:30

Box Summary

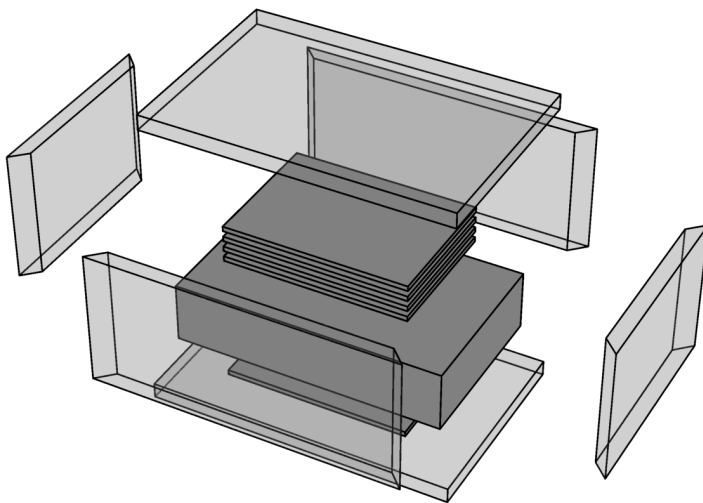

	Box Dimensions	
	Outer	Inner
Length	595.mm	535.mm
Width	395.mm	335.mm
Height	320.mm	260.mm
Volume	75.21 ltr.	46.60 ltr.

Wall	Thickness [mm]	Transmittance [W/(m²K)]	Transmission [W/K]
Left	30.	1.3	0.138775
Right	30.	1.3	0.138775
Front	30.	1.3	0.214175
Back	30.	1.3	0.214175
Bottom	30.	1.3	0.269263
Top	30.	1.3	0.269263
			Σ = 1.24443

Sensor Temperatures

