

# Simulation Results for K&V - Art. 2262 - Frühling, Herbst

Created by Ivonsee on 2016-10-07 09:44:44

## Box Summary

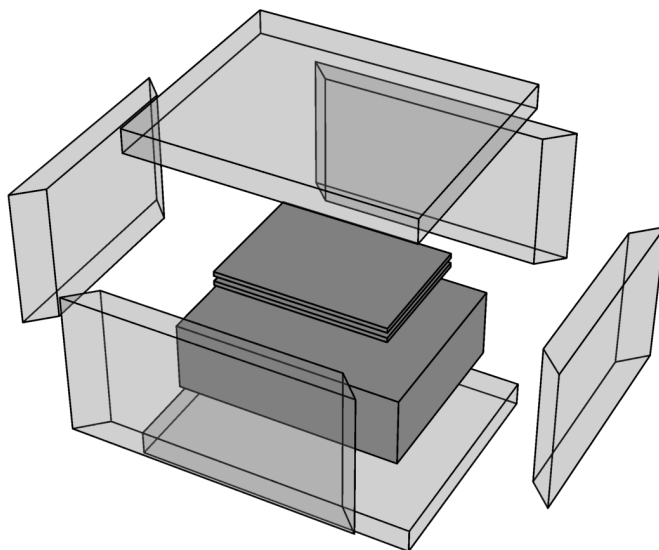

	Box Dimensions	
	Outer	Inner
Length	575.mm	475.mm
Width	480.mm	380.mm
Height	395.mm	295.mm
Volume	109.02 ltr.	53.25 ltr.

Wall	Thickness [mm]	Transmittance [W/(m <sup>2</sup> K)]	Transmission [W/K]
Left	50.	0.78	0.117663
Right	50.	0.78	0.117663
Front	50.	0.78	0.143228
Back	50.	0.78	0.143228
Bottom	50.	0.78	0.178035
Top	50.	0.78	0.178035
			<b>Σ = 0.877851</b>

# Sensor Temperatures

